

Insert Bearing

UC300 Series-UC320-64

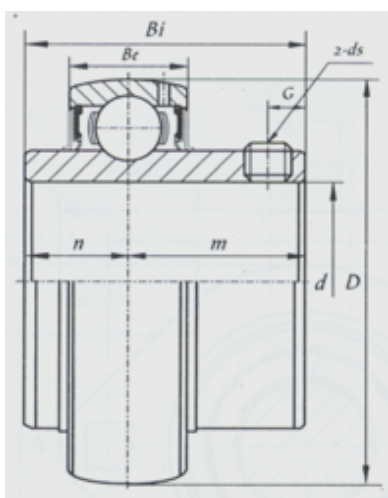

Bearing No.	UC320-64
d	
(mm)	101.6
(in.)	4
Dimensions [mm]	
D	215
Bi	108
Be	54
n	42
m	66
G	18
ds	5/8-18UNF

HEBEI HUANSHENG BEARING CO., LTD-Tel:+86-0319-8541203-Email:hbhs@hbhsbearing.com-
www.hbhsbearing.com