

Insert Bearing

UC300 Series-UC315

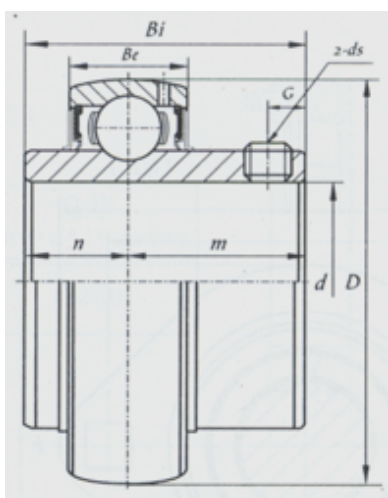

Bearing No.	UC315
d	
(mm)	75
(in.)	
Dimensions [mm]	
D	160
Bi	82
Be	42
n	32
m	50
G	14
ds	M14x1.5

HEBEI HUANSHENG BEARING CO., LTD-Tel:+86-0319-8541203-Email:hbhs@hbhsbearing.com-
www.hbhsbearing.com