

Insert Bearing

UC300 Series-UC308-24

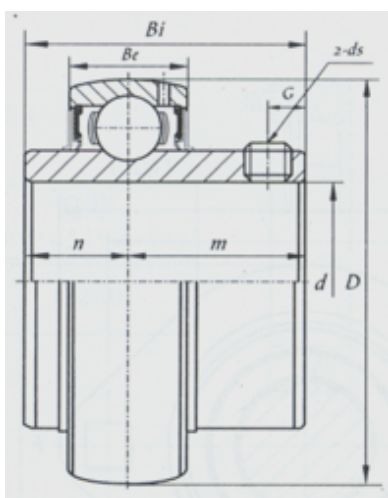

Bearing No.	UC308-24
d	
(mm)	38.1
(in.)	1.5
Dimensions [mm]	
D	90
Bi	52
Be	28
n	19
m	33
G	10
ds	3/8-24UNF

HEBEI HUANSHENG BEARING CO., LTD-Tel:+86-0319-8541203-Email:hbhs@hbhsbearing.com-
www.hbhsbearing.com