

Insert Bearing

UC300 Series-UC307-22

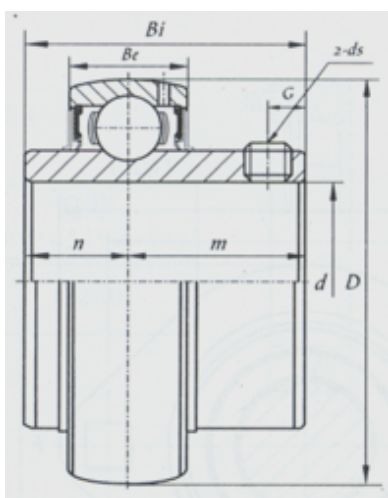

Bearing No.	UC307-22
d	
(mm)	34.925
(in.)	1.375
Dimensions [mm]	
D	80
Bi	48
Be	26
n	19
m	29
G	8
ds	5/16-24UNF

HEBEI HUANSHENG BEARING CO., LTD-Tel:+86-0319-8541203-Email:hbhs@hbhsbearing.com-
www.hbhsbearing.com