

Insert Bearing

UC300 Series-UC305-14

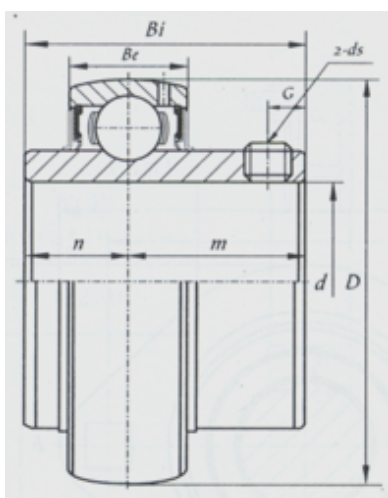

Bearing No.	UC305-14
d	
(mm)	22.225
(in.)	0.875
Dimensions [mm]	
D	62
Bi	38
Be	22
n	15
m	23
G	6
ds	1/4-28UNF

HEBEI HUANSHENG BEARING CO., LTD-Tel:+86-0319-8541203-Email:hbhs@hbhsbearing.com-
www.hbhsbearing.com