

Insert Bearing

CS Series-**CS210**

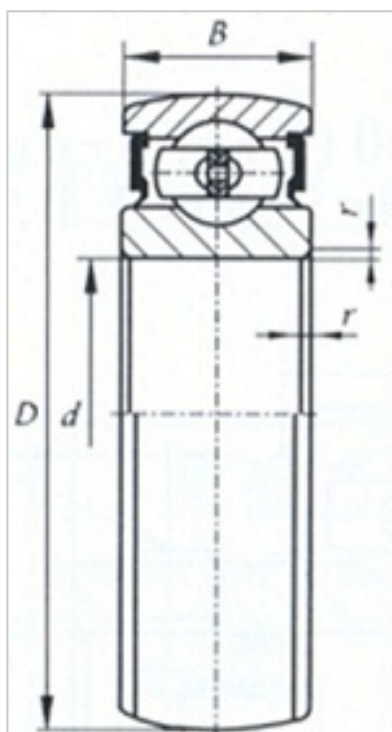

Bearing Designation	CS210
Dimension [mm]	
d	50
D	90
C	20
B	20
r min	1.1
Basic load ratings (kN)	
Cr	3500
Cor	2320



HEBEI HUANSHENG BEARING CO., LTD-Tel:+86-0319-8541203-Email:hbhs@hbhsbearing.com-
www.hbhsbearing.com