

外球面轴承

NA 系列-NA211-35

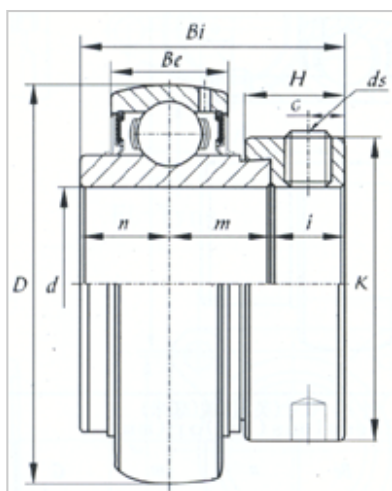

型号	NA211-35
d	
(mm)	55.563
(in.)	2 3/16
尺寸 (mm)	
D	100
Be	25
Bi	71.4
B1	55.6
n	27.8
K	76.2
H	20.7
G	8
ds	3/8-24UNF
基本额定载荷 (kN)	
Cr	4350
Cor	2900