

外球面轴承

NA 系列-NA209-26

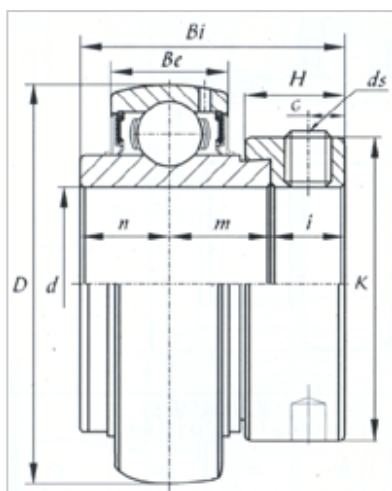

型号	NA209-26
d	
(mm)	41.275
(in.)	1 5/8
尺寸 (mm)	
D	85
Be	22
Bi	56.3
B1	42.8
n	21.4
K	63.5
H	18.3
G	6.5
ds	5/16-24UNF
基本额定载荷 (kN)	
Cr	3180
Cor	2050