

外球面轴承

NA 系列-NA208-25

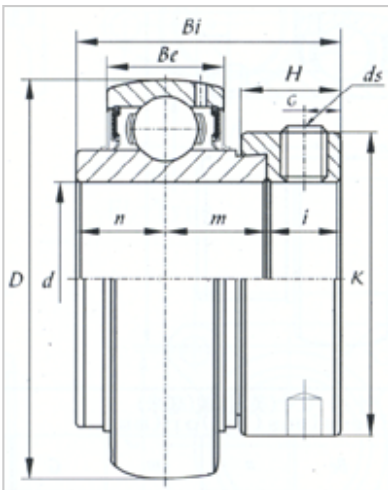

型号	NA208-25
d	
(mm)	39.688
(in.)	1 9/16
尺寸 (mm)	
D	80
Be	21
Bi	56.3
B1	42.8
n	21.4
K	60.3
H	18.3
G	6.5
ds	5/16-24UNF
基本额定载荷 (kN)	
Cr	2950
Cor	1800