

外球面轴承

NA 系列-NA207

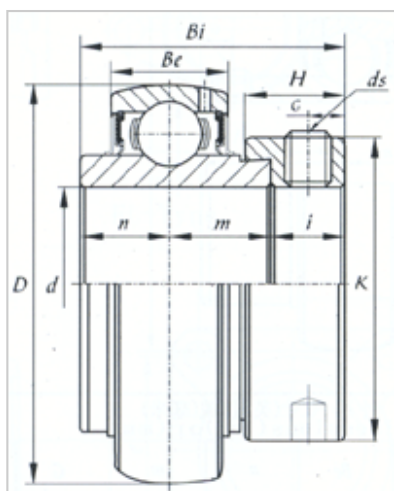

型号	NA207
d	
(mm)	35
(in.)	
尺寸 (mm)	
D	72
Be	20
Bi	51.1
B1	37.6
n	18.8
K	55.6
H	17.5
G	6.5
ds	M8x1
基本额定载荷 (kN)	
Cr	2550
Cor	1500