

外球面轴承

NA 系列-NA207-22

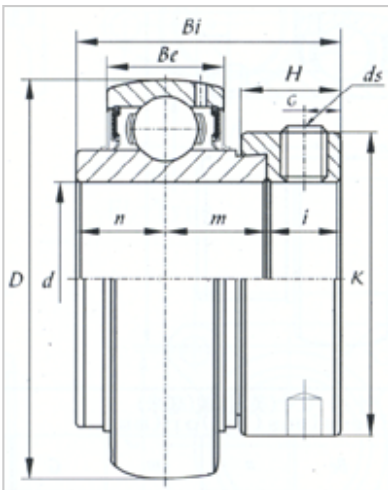

型号	NA207-22
d	
(mm)	34.925
(in.)	1 3/8
尺寸 (mm)	
D	72
Be	20
Bi	51.1
B1	37.6
n	18.8
K	55.6
H	17.5
G	6.5
ds	5/16-24UNF
基本额定载荷 (kN)	
Cr	2550
Cor	1500