

外球面轴承

NA 系列-NA206-18

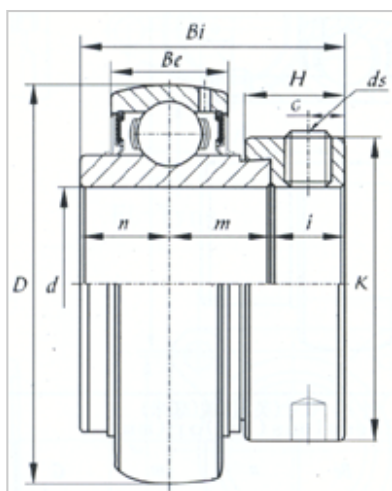

型号	NA206-18
d	
(mm)	28.575
(in.)	1 1/8
尺寸 (mm)	
D	62
Be	19
Bi	48.4
B1	36.6
n	18.3
K	44.5
H	15.9
G	6
ds	5/16-24UNF
基本额定载荷 (kN)	
Cr	1900
Cor	1100