

外球面轴承

NA 系列-NA210

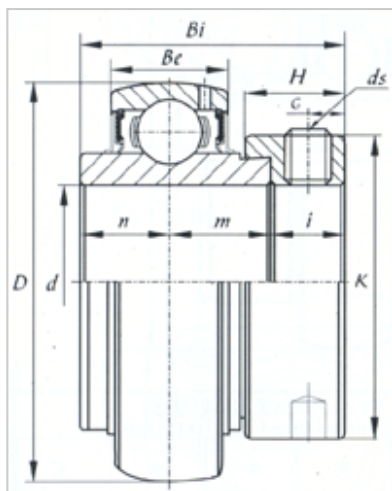

型号	NA210
d	
(mm)	50
(in.)	
尺寸 (mm)	
D	90
Be	24
Bi	62.7
B1	49.2
n	24.6
K	69.9
H	18.3
G	6.5
ds	M8x1
基本额定载荷 (kN)	
Cr	3500
Cor	2300